

SECTION A-A

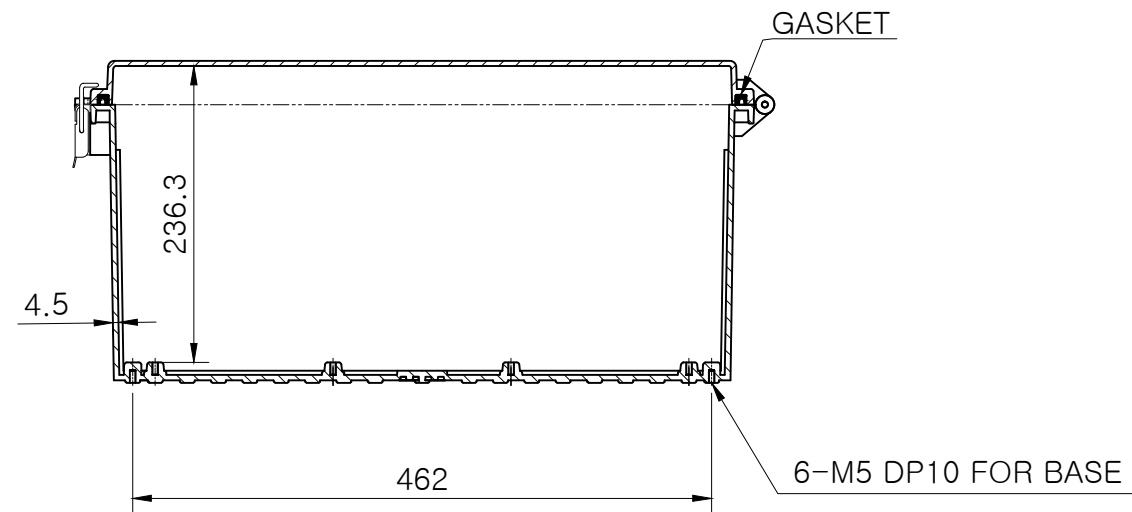
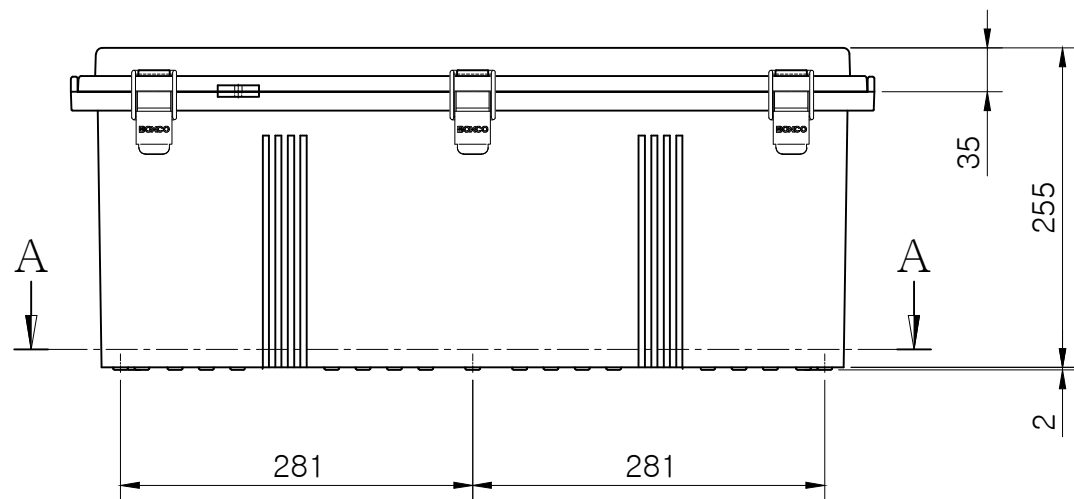

SECTION B-B

Note.

MODEL (모델)	BC-□□P-506025	D R (재도)	JUNG,Y.J.	16.05.09	UNIT (단위)	mm
ASSY (완성 규격)	530 * 630 * 255	C K (검도)	PARK,Y.J.	16.05.09	SCALE (척도)	1:6
DWG NO (도번)	P-506025-03	A P (승인)	KIM,D.S.	16.05.10	REV. (개정)	0
MATERIAL (재질)						

