

SECTION A-A

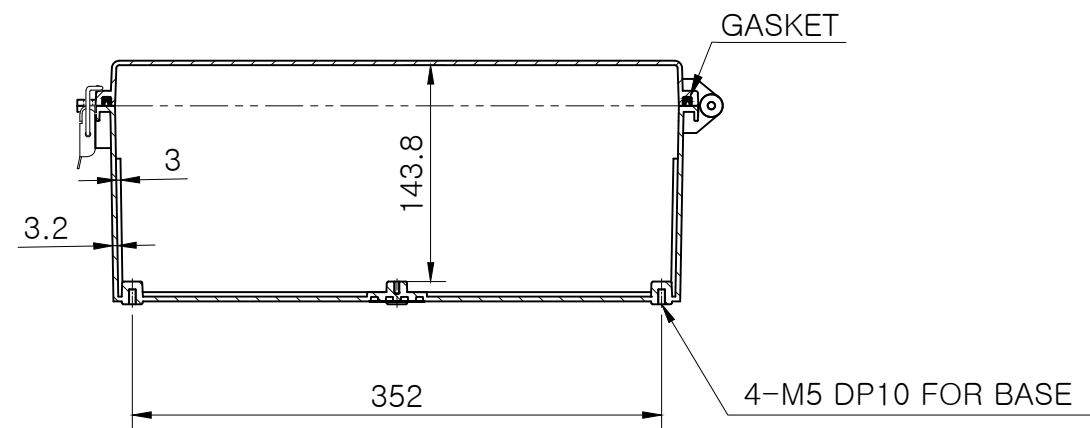
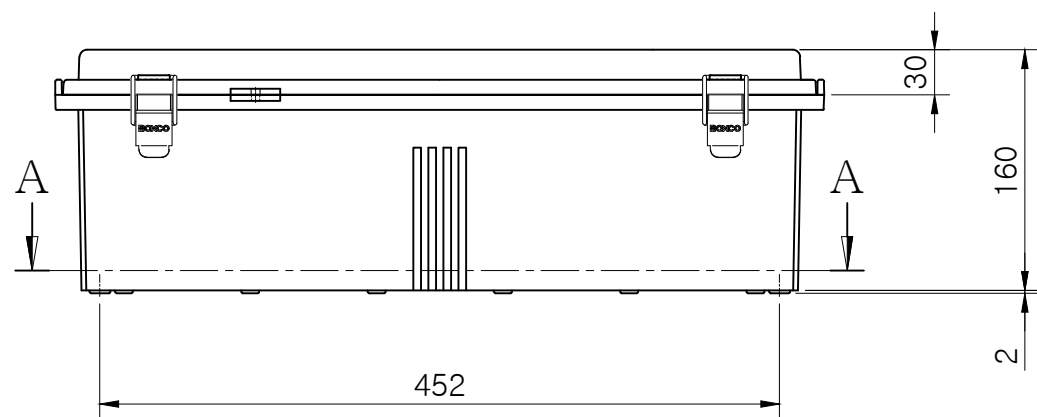

SECTION B-B

Note.

MODEL (모델)	BC-□□P-405016	D R (재도)	JUNG, Y.J.	16.04.28	UNIT (단위)	mm	
ASSY (완성 규격)	401 * 501 * 160	C K (검도)	PARK, Y.J.	16.04.28	SCALE (척도)	1:5	
DWG NO (도번)	P-405016-03	MATERIAL (재질)	A P (승인)	KIM, D.S.	16.04.29	REV. (개정)	0

BOXCO[®]