

SECTION A-A

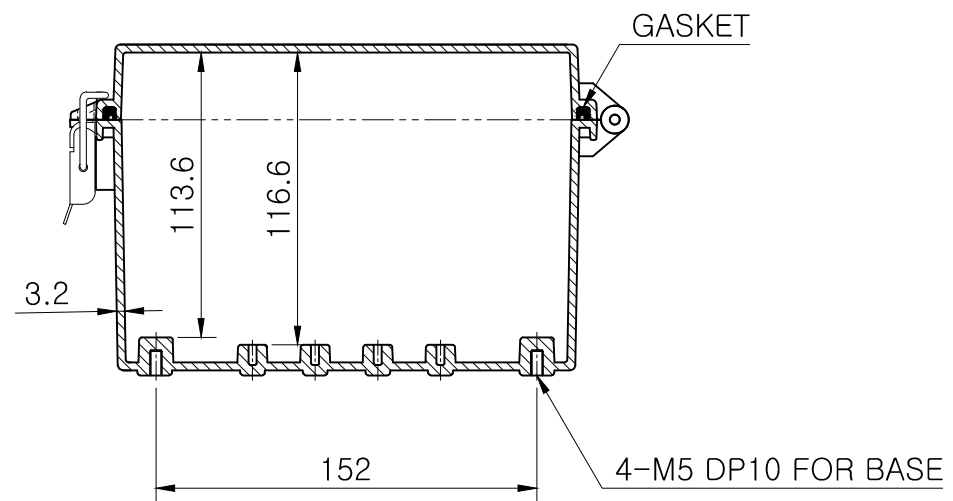
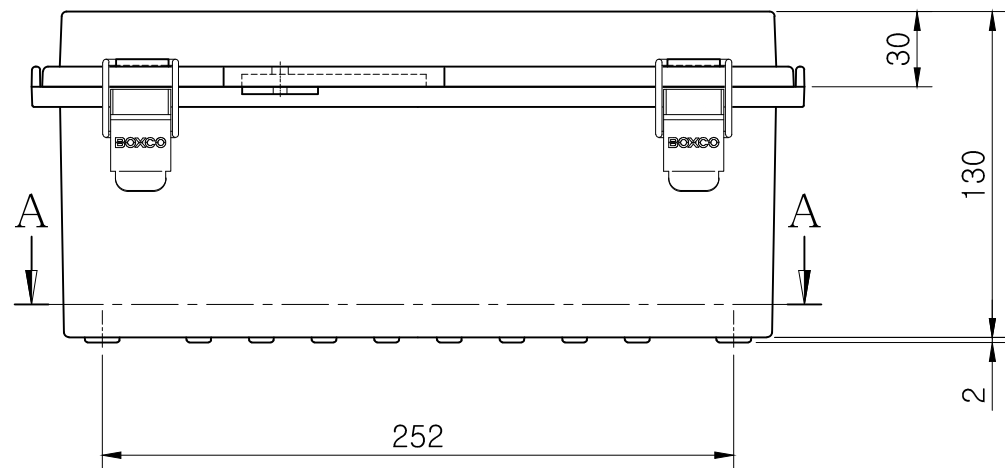

SECTION B-B

Note.

MODEL (모델)	BC-□□P-203013			D R (재도)	JUNG,Y.J.	16.04.12	UNIT (단위)	mm
ASSY (완성 규격)	200 * 300 * 130			C K (검도)	PARK,Y.J.	16.04.12	SCALE (척도)	1:3
DWG NO (도번)	P-203013-03	MATERIAL (재질)		A P (승인)	KIM,D.S.	16.04.13	REV. (개정)	0

BOXCO[®]