

SECTION A-A

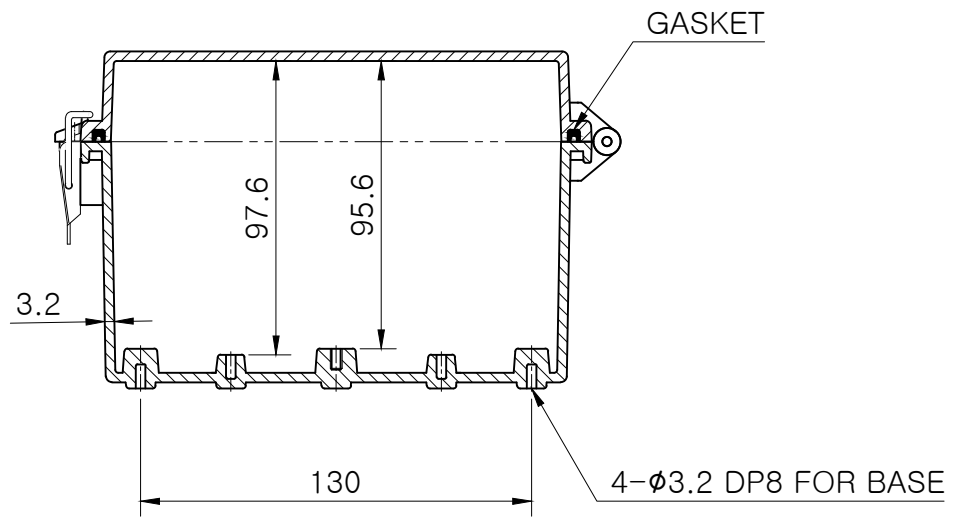
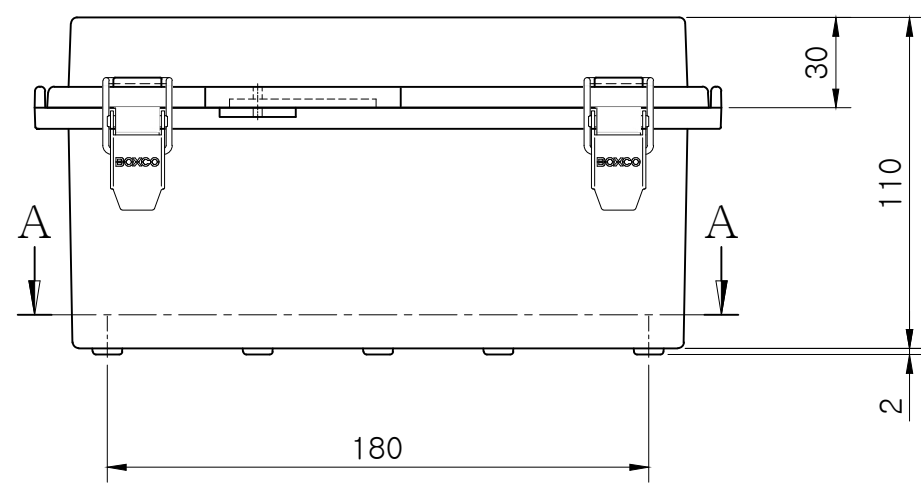

SECTION B-B

Note.

MODEL (모델)	BC-□□P-172211		D R (재도)	JUNG,Y.J.	16.04.08	UNIT (단위)	mm
ASSY (완성 규격)	170 * 220 * 110		C K (검도)	PARK,Y.J.	16.04.08	SCALE (척도)	1:2.5
DWG NO (도번)	P-172211-03	MATERIAL (재질)	A P (승인)	KIM,D.S.	16.04.09	REV. (개정)	0

