

SECTION A-A

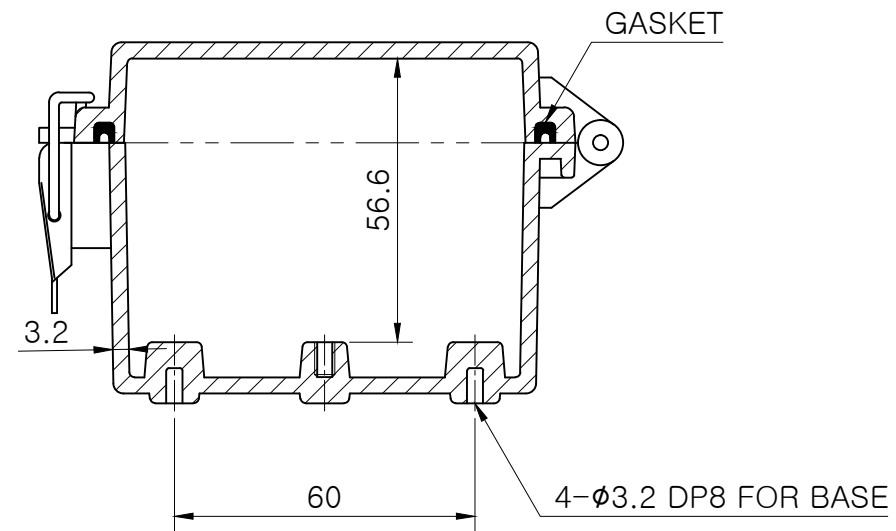
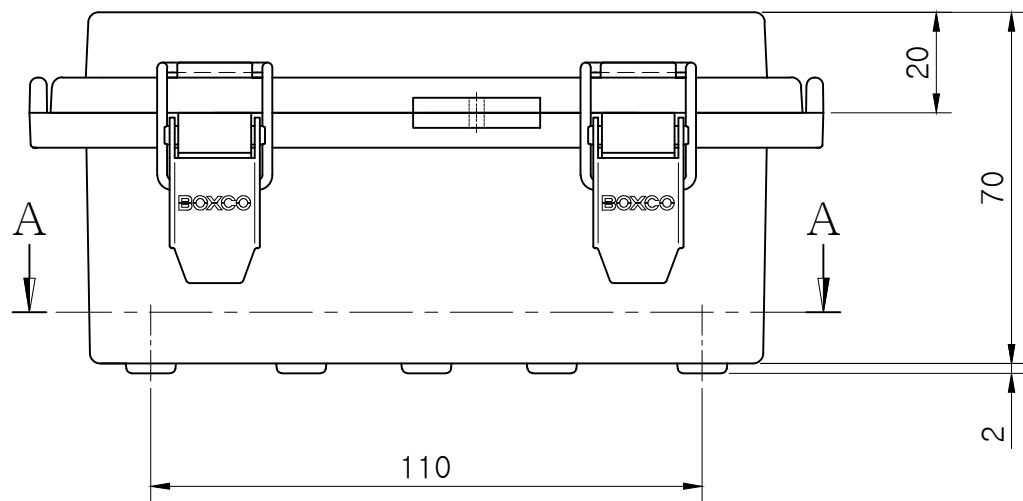

SECTION B-B

Note.

MODEL (모델)	BC-□□P-101507			D R (재도)	JUNG,Y.J.	16.03.18	UNIT (단위)	mm
ASSY (완성 규격)	100 * 150 * 70			C K (검도)	PARK,Y.J.	16.03.18	SCALE (척도)	1:1.5
DWG NO (도번)	P-101507-03	MATERIAL (재질)		A P (승인)	KIM,D.S.	16.03.19	REV. (개정)	0

BOXCO[®]