

SECTION A-A

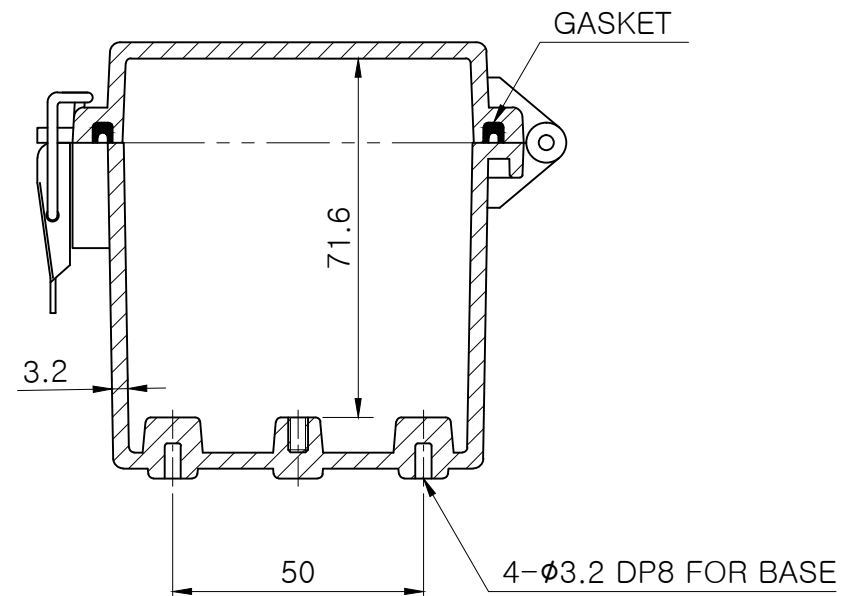
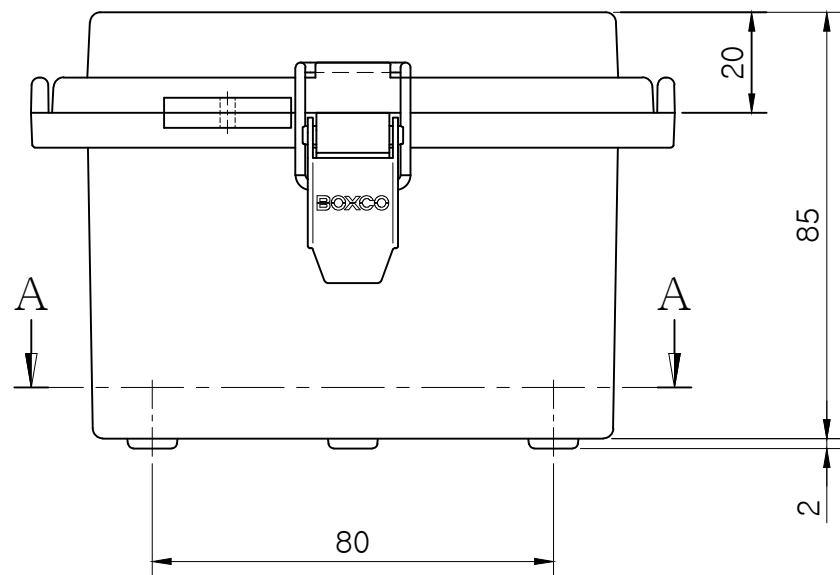

SECTION B-B

Note.

MODEL (모델)	BC-□□P-091208	D R (제 도)	JUNG, Y.J.	16.03.17	UNIT (단 위)	mm	
ASSY (완성 규격)	90 * 120 * 85	C K (검 도)	PARK, Y.J.	16.03.17	SCALE (척 도)	1:1.5	
DWG NO (도 번)	P-091208-03	MATERIAL (재 질)	A P (승 인)	KIM, D.S.	16.03.18	REV. (개 정)	0

**BOXCO**<sup>®</sup>